

ROOF FANS



BRF

AC CENTRIFUGAL ROOF FANS Horizontal Outlet

For increasing indoor air quality, BRF roof fans work silently with their external rotor motors. The unit works trouble-free on the highest performance.

Technical Drawings

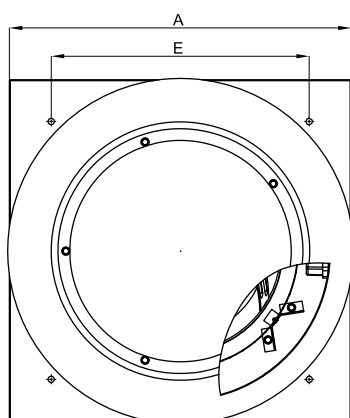
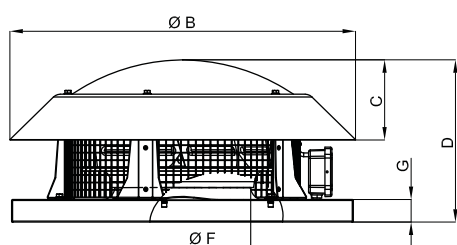

- MATERIAL** : The housing is made of electrostatic powder coated sheet iron, backward impeller is made of galvanized sheet metal.
- INSULATION CLASS** : Class B or Class F
- DIRECTIVE** : EN 60335-1, EN 60335-2-80
- SPEED CONTROL** : Speed can be adjusted using an optional controller.
- APPLICATION AREAS** : For industrial and constructional applications, in factories, hospitals, night clubs, offices, kitchens, bathrooms, theaters, condominiums, restaurants, etc.

TYPE	A	B	C	D	E	F	G
BRF 160	252	260	50	140	210	80	25
BRF 180	252	260	50	140	210	80	25
BRF 225	336	386	105	212	274	146	35
BRF 250	370	386	105	225	290	163	35
BRF 315	454	443	135	293	333	185	40
BRF 355	595	595	135	285	450	234	40
BRF 400	595	685	145	355	450	270	40
BRF 450	664	685	145	400	450	282	40
BRF 500	798	824	155	385	600	320	40
BRF 560	798	824	155	400	600	360	40

Dimensions are in (mm)

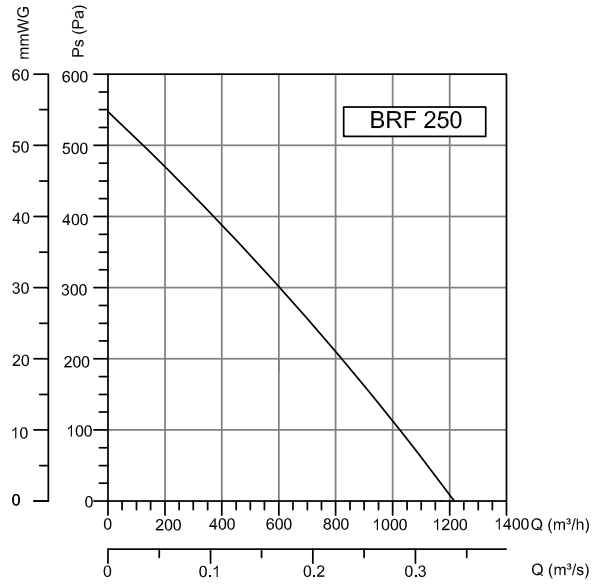
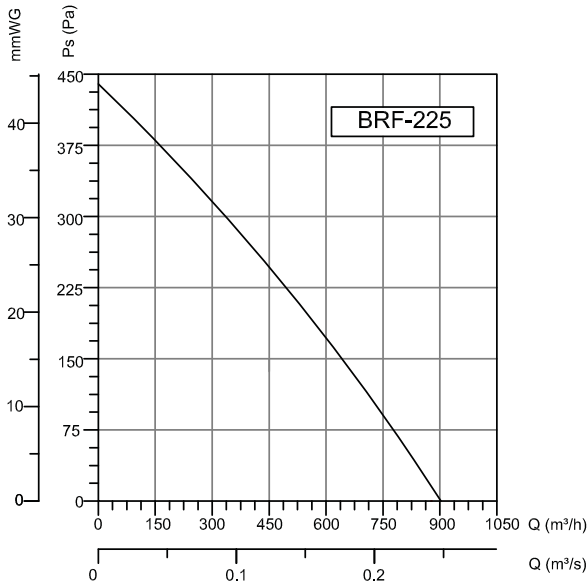
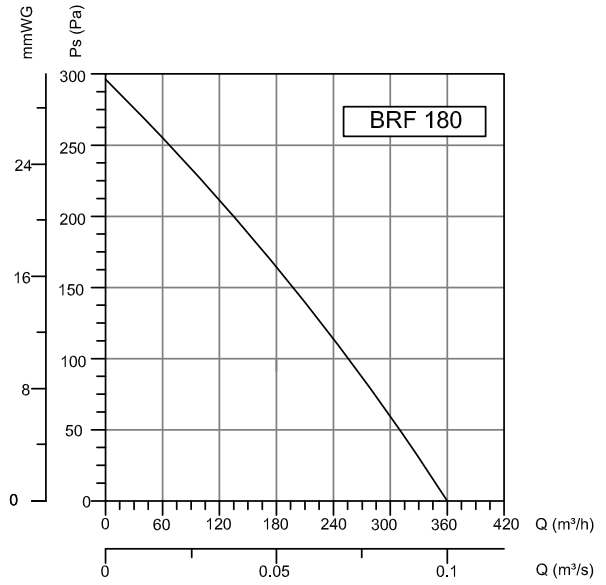
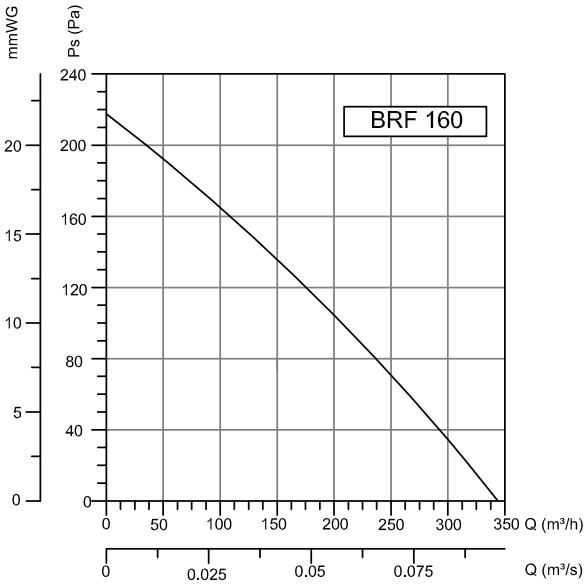

TYPE	VOLTAGE	FREQUENCY	POWER	CURRENT	CAPACITOR	SPEED	AIR FLOW	SOUND PRESSURE LEVEL	WEIGHT
	V	Hz	W	(A)	(μ F)	d/d	m ³ /h	dB(A)	kg
BRF 160	230	50	65	0,3	2	2547	346	46	3,5
BRF 180	230	50	80	0,35	2.5	2500	360	50	3,7
BRF 225	230	50	130	0,6	5	2640	902	54	7
BRF 250	230	50	120	0,8	6	2685	1212	55	8
BRF 315	230	50	180	0,6	6	1400	1500	56	12,8
BRF 355	230	50	220	1,1	6	1400	2400	65	18
BRF 400	230	50	345	1,5	12	1400	3500	68	22
BRF 450	230	50	620	2,8	18	1400	5000	72	28
BRF 500	380	50	950	2,4	-	1400	7550	72	45,5
BRF 560	380	50	1550	2,8	-	1400	9600	80	48

DUCT FANS

ROOF FANS

AXIAL FANS

RADIAL FANS

PLASTIC FANS

VENTILATORS

SMOKE EXHAUST SYSTEMS

ACCESSORIES

ROOF FANS

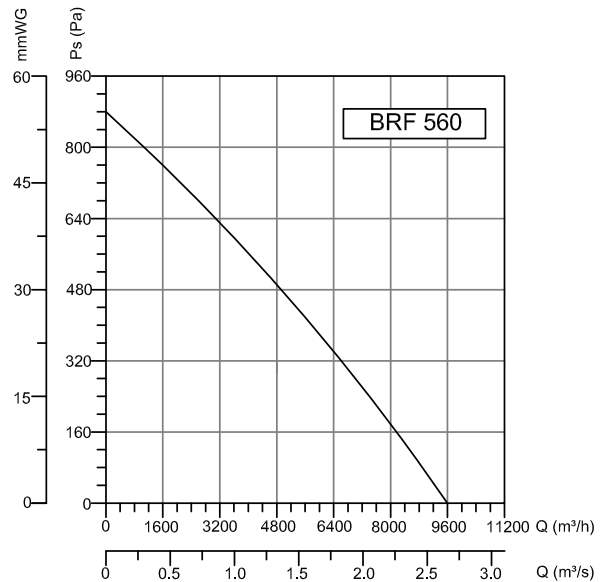
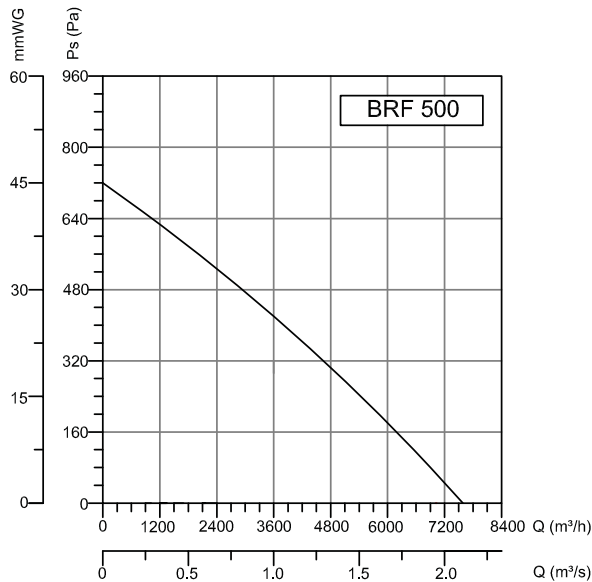
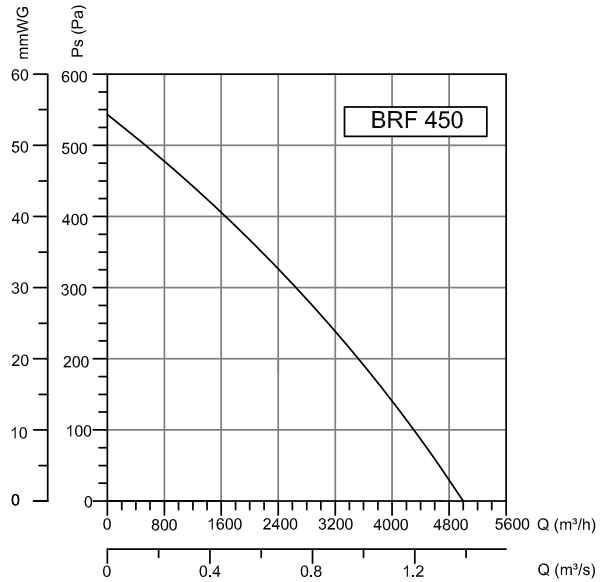
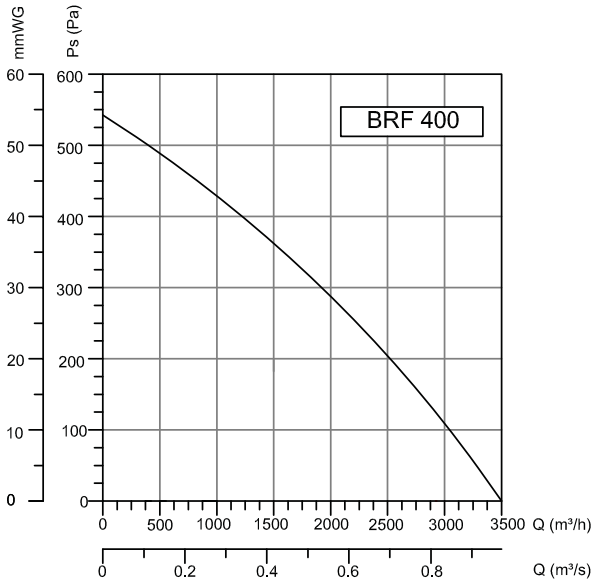
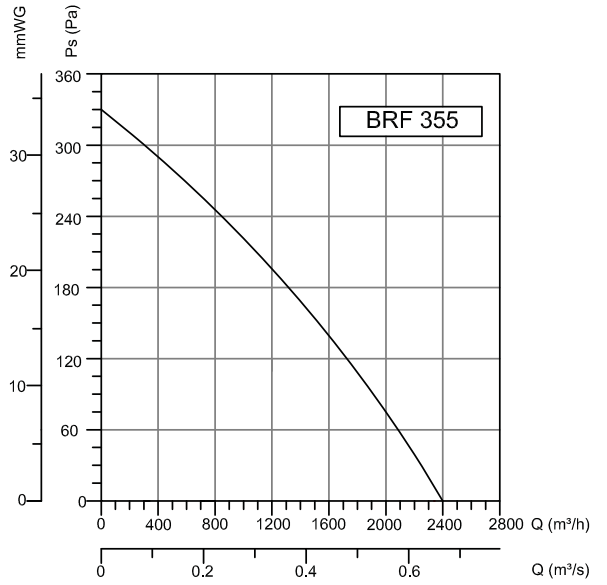
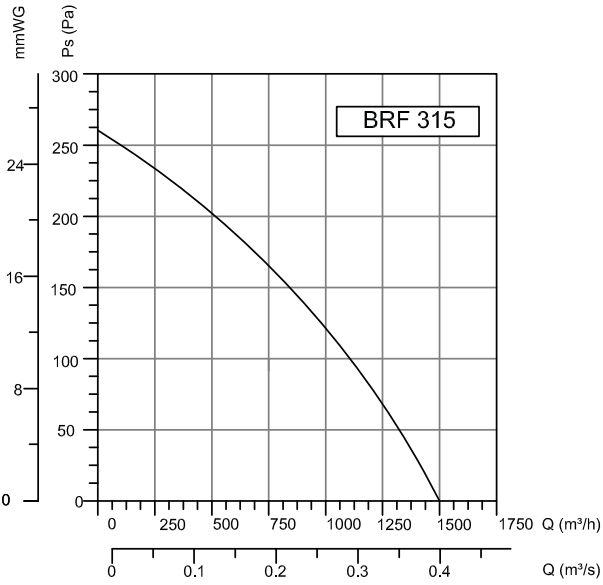

Accessories



BSC



BSC-F

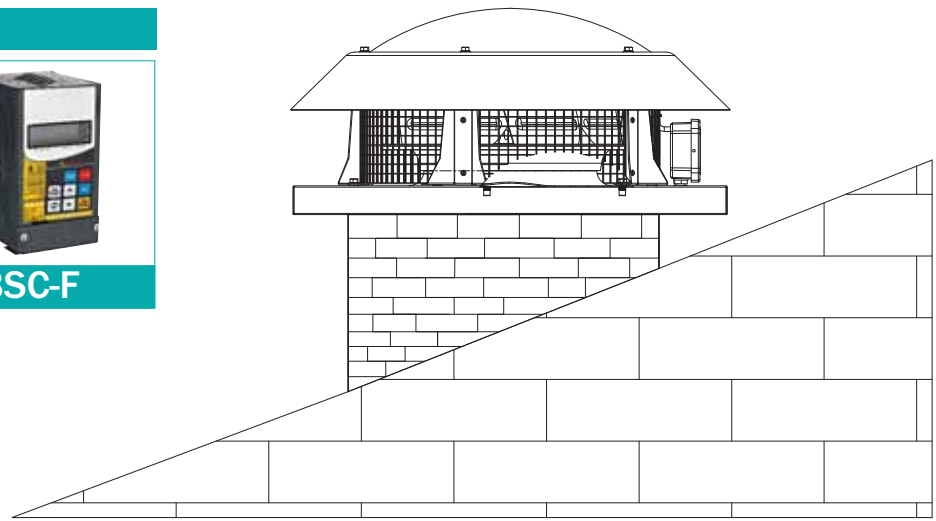

DUCT FANS

ROOF FANS

AXIAL FANS

RADIAL FANS

PLASTIC FANS

VENTILATORS

SMOKE EXHAUST SYSTEMS

ACCESSORIES